



# SUMMER PRODUCTS



**A LINE THAT  
DELIVERS RESULTS!**

**BUILT TO  
LAST**



# OUR SUMMER PRODUCTS



Throughout the years we have helped farmers accomplish more work and be more productive by developing several innovative products.

The original material bucket is a key example, no one has designed a better bucket to pick up all sizes of rocks, it is by far the most rugged and durable bucket on the market.

For more extensive field conditions, we've developed a complete range of rock rakes designed to move rocks into a windrow for easier handling.

Land leveling has become an important aspect of land and crop management, at S.Houle we offer a wide range of models to help farmers in all sorts of applications. From small 2WD tractors to big 4WD's we have the right size and fit, simply chose between 5 models from 8 to 24 feet (2.43 - 7.34 m).

For cleaning ditches and improve field drainage you may also use one of our two available ditchers.

Land management is not complete unless you have a tool to handle trees, why not choose from our selection of 3 models of tree shears that fit most tractors, skid steer loaders, telehandlers or mini-excavators. You can cut trees or limbs up to 16 inches (40 cm) in diameter.

Finally, help clean branches, roots and debris using our heavy duty grapples mounted on our material buckets.

# TABLE OF CONTENTS



<b>MATERIAL BUCKETS</b>	<b>6</b>
<b>QUICK ATTACH</b>	<b>12</b>
<b>GRAPPLES</b>	<b>16</b>
<b>ROCK RAKES</b>	<b>18</b>
<b>LAND LEVELERS</b>	<b>24</b>
<b>DITCH BLADES</b>	<b>29</b>
<b>TREE SHEARS</b>	<b>30</b>



# BB, B, HB & SHB SERIES

S.Houle material buckets are unique on the market. With unmatched tip design and high quality steel we ensure you have the most robust tool to accomplish your work.

Our tips are specially designed to support maximum weight up to 3 times what standard models can offer. Their specially designed profile offers a stopper that allows for more volume capacity by keeping rocks from tumbling back. We have such confidence in our product that we offer a limited lifetime warranty on tips.

Our focus is not only on buckets, we also insure that our attaching brackets have the right angle that matches your OEM equipment.

It is clear that our material buckets are not like any other one on the market and because we believe that our customers deserve the best, we have put the engineering and attention to details to make our material buckets highly productive tools.

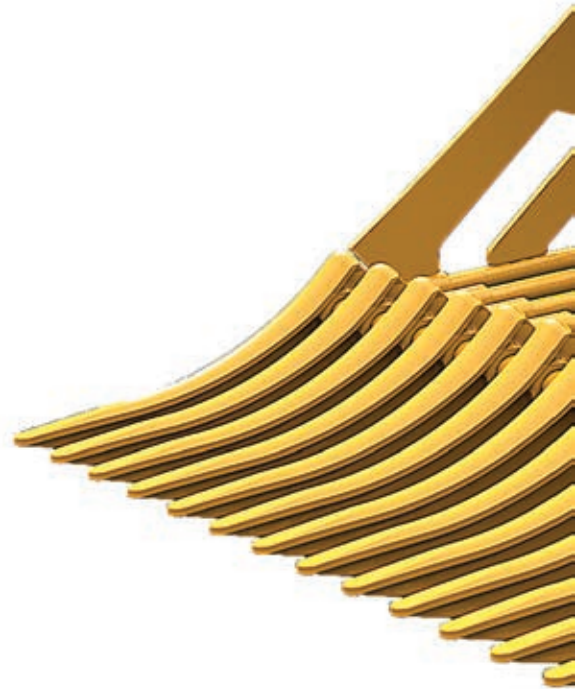

## Industry Standards vs. S. Houle Model Strength and Side Load



The new forged steel tips offer **75%** More resistance to wear



When compared to the industry standard, S. Houle's new tip with 1 1/4" (3.2 cm) steel rod is 98% stronger for vertical and side loads. Even more impressive is the tip with 1 1/2" (4 cm) rod that jump to 173% stronger on vertical loads and 144% stronger on side loads.



*The industry standard tips are shaped with the rod ends which bend over time.*

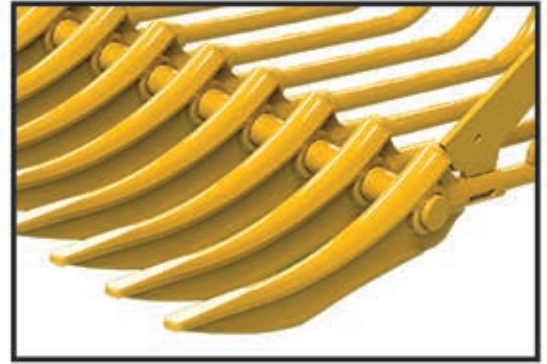

*S. Houle's new model tips are made of forged steel that will not bend even under the most rigorous conditions.*

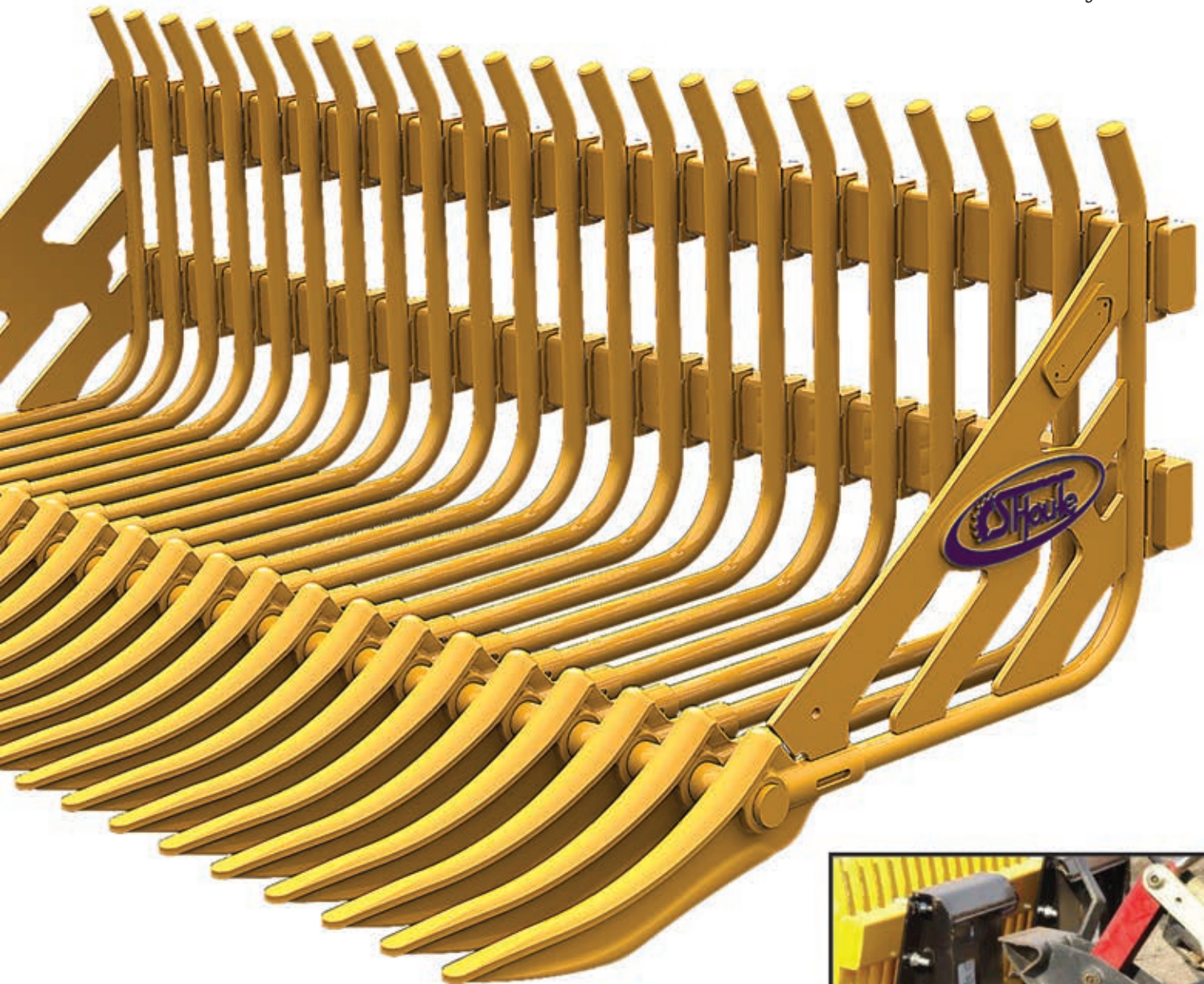

*Attaching brackets are designed to respect the original manufacturer's designed angles.*

# BBW & BB SERIES



The BB Model is designed for tractors ranging from 30 to 60 HP (22-45 KW) or for small skid steer loaders. This model is ideal for picking up rocks on the surface of the ground.

**Tine Diameter:** 1.125" (28 mm).

**Space Between Tines:**

BBW Series: 2.5" (64 mm) • BB Series: 1.75" (45 mm).

**Height:** 24.75" (63 cm).

**Depth:** 34" (87 cm).

**Tensile Strength:** 101,250 lb (46 000 kg).



## BBW Series - 30 to 60 HP (22-45 KW)

MODEL	WIDTH in / cm	WEIGHT lb / kg	NO OF TINES
BB-4W	49 / 124	400 / 182	14
BB-5W	60 / 152	477 / 217	17
BB-6W	75 / 191	585 / 266	21
BB-7W	86 / 218	665 / 302	24

## BB Series - 30 to 60 HP (22-45 KW)

MODEL	WIDTH in / cm	WEIGHT lb / kg	NO OF TINES
BB-4	47 / 120	480 / 218	17
BB-5	62 / 160	600 / 272	21
BB-6	70 / 178	705 / 320	25
BB-7	82 / 210	780 / 354	29

# B SERIES



The B Model material bucket is suitable for tractors from 60 to 100 HP (45-75 KW) as well as skid-steer loaders and backhoes. This material bucket is designed to pick up rocks at ground surface. With care, it can also be used for light digging.

**Tine Diameter:** 1.25" (32 mm).

**Space Between Tines:** 2.5" (64 mm).

**Height:** 24.75" (63 cm).

**Depth:** 45" (114 cm).

**Tensile Strength:** 112,500 lb (51 000 kg).

## B Series - 60 to 100 HP (45-75 KW)

MODEL	WIDTH in / cm	WEIGHT lb / kg	NO OF TINES
B-5	58 / 147	581 / 264	16
B-6	70 / 178	760 / 345	19
B-7	81 / 206	875 / 397	22
B-8	92 / 234	990 / 450	25

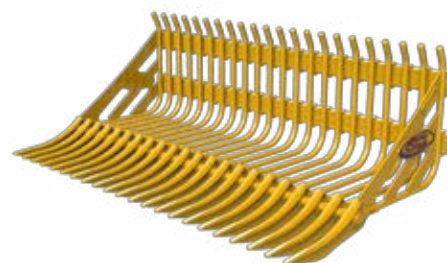

# HB SERIES



The HB Model is intended for use with tractors ranging from 85 to 200 HP (63-150 KW). This bucket will scoop rocks that lay on the surface of the ground but can also dig up medium sized rocks. To provide the most leverage simply position the fork so it is centered near the rock you wish to unearth.

- Tine Diameter:** 1.5" (38 mm).
- Space Between Tines:** 3" (76 mm).
- Height:** 24.75" (63 cm).
- Depth:** 41.25" (105 cm).
- Tensile Strength:** 135,000 lb (61 000 kg).



## HB Series - 85 to 200 HP (63-150 KW)

MODEL	WIDTH <i>in / cm</i>	WEIGHT <i>lb / kg</i>	NO OF TINES
HB-5	61 / 155	705 / 320	14
HB-6	70 / 178	820 / 372	16
HB-7	88 / 223	990 / 450	19
HB-8	97 / 246	1110 / 504	22
HB-9	110 / 279	1375 / 624	25



# SHB SERIES



The SHB Model is built for industrial loaders and can also be mounted on any large backhoe loader. Each tine is reinforced with a high strength steel plate for maximum durability. With the strength of this bucket, you can dig up and move any kind of debris.

**Tine Diameter:** 1.75" (45 mm).

**Space Between Tines:** 4" (100 mm).

**Height:** 32" (81 cm).

**Depth:** 44.25" (112 cm).

**Tensile Strength:** 157,500 lb (71 450 kg).

## SHB Series - more than 200 HP (145 KW+)

MODEL	WIDTH in / cm	WEIGHT lb / kg	NO OF TINES
SHB8	100 / 254	2075 / 943	18
SHB9	112 / 285	2205 / 1002	20



# QUICK ATTACH

PRODUCT NO	MODEL	OLD CODE	WEIGHT lb / kg
IN-20E12	Universal Attachment	UA100	76 / 35
IN28-00001	Allied 2595 Direct	ALL2595	120 / 54
IN28-00004	Allied 595 QA	ALL595Q	105 / 48
IN28-00003	Allied 795	ALL795	153 / 69
IN28-00002	Allied 895	ALL895	115 / 52
IN41-00001	Allied EURO 2595	EU 2595	125 / 57
IN20-00002	Alo 300, 400, 600, 700, 900 (T4)	AO600	115 / 52
IN20-00004	ALO (T5)		365 / 166
IN22-00003	ASV RC50, RC60 QA	SSQA150	125 / 57
BC1836	Bobcat 1836	BC1836	100 / 45
IN31-00001	Bush Hog 2426, 2426, 2446, 2846	BH2426	96 / 44
BH345	Bush Hog M 346, 446, 546, 646	BH345	100 / 45
CD580	Case 580C Direct	CD580	133 / 60
IN02-00006	Case 580K/570 LTX Direct	CD570	150 / 68
IN02-00014	Case 580L Direct (T4)		174 / 79
IN02-00012	Case 580M Direct (T4)		179 / 81
IH600	Case IH Inter 650 Direct	IH600	118 / 54
IN02-00005	Case IH L300, 510, 520	IH300	214 / 97
IN20-00002	Case LX 162 - 172, L400, TO L750, LX156 QA	A0600	105 / 48
IN33-00001	FENDT	FENDT	122 / 55
IN03-00003	Ford 445D IND	FO445D	183 / 83
IN22-00003	Ford N.H. 16-17LA, 32-33LA QA	SSQA150	125 / 57
IN22-00003	Ford N.H. 46LB, 52LA-LB-LC QA	SSQA150	125 / 57
IN25-00002	Ford N.H. 7312-14, 7411-12-13, 7511	FNH7400	153 / 69
IN25-00001	Ford N.H. 9030, 276, 7414, 256	FNH9030	160 / 73
IN03-00004	Ford N.H. TV 140 (T4)	FNHTV140	194 / 88
GE1843	Gehl 1843	GE1843	65 / 29
IN29-00001	Gehl 3825/3725	GE3825	105 / 48
IN44-00001	Global loader (T4)		312 / 142
GB2805	Great Bend 2805	GB2805	
IN30-00001	Great Bend 660	GB660	100 / 45
IN30-00002	Great Bend 880	GB880	96 / 44
IN24-00001	HARDY	HY200	145 / 66



ALO600



Case IH L300, 510, 520



Ford NH 7312-14, 7411-13, 7511



Ford NH 9030, 276, 7414, 256



Ford NH TV140

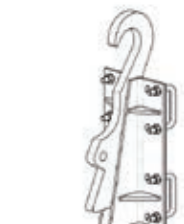

Hardy

# QUICK ATTACH

PRODUCT NO	MODEL	OLD CODE	WEIGHT lb / kg	
IN01-00031	J.D.145 Direct (T4)	JD145	109 / 49	
IN01-00014	J.D. 240, 245, 260, 265 (T4)	JD240	109 / 49	
IN01-00029	J.D. 244E (T4)		237 / 108	
IN01-00015	J.D. 244J Euro (T4)	JD244J	122 / 55	
JD244JSHB	J.D. 244J Euro (SHB)	JD244JSHB	140 / 64	
IN01-00021	J.D.280	JD280	140 / 64	
IN01-00025	J.D. 310G/410G indust Q-A(T4)	JD310G	190 / 86	
IN01-00020	J.D. 3400, 3800 Tele Boom (T4)	JD3800	180 / 82	
IN01-00043	J.D.400X (T4)		89 / 40	
IN01-00019	J.D.410, 419,430, 440, 460	JD400	100 / 45	
IN01-00040	J.D.480H Global			
IN01-00019	J.D.520 ,521, 540, 541, 542	JD500	100 / 45	
IN01-00008	J.D. 544 (T5)		200 / 90	
IN01-00013	J.D.620, 640, 720, 725, 740, 741, (T4)	JD600	160 / 73	
IN01-00022	J.D. 840 (T4)	JD800	351 / 159	
IN01-00032	J.D. 840 (T5)		415 / 188	
JCB	JCB 165,185,1105, QA	JCB	185 / 84	
IN13-00001	JCB 210		153 / 69	
JCB508	JCB 506,508	JCB508	101 / 46	
IN13-00006	JCB 524-50 (T4)		106 / 48	
IN21-00007	JRB 416 (T4)		271 / 123	
IN21-00003	JRB 416 (T5)		306 / 139	
IN21-00002	JRB DEERE E SERIES (T4)		233 / 106	
JD575QA	JD 575 Skid Steer loader Q.A.	JD575QA		
IN32-00001	KD Loader 5500	KD5500	60 / 27	
KK3456	Koyker 310, 345, 400, 500, 510, 545, 600, 645	KK3456	155 / 70	
IN04-00001	Kubota LA 1251 (T4)	KULA1251	96 / 44	
IN04-00003	Kubota LA 402 Direct (T4)	KULA402	75 / 34	
KUM1250	Kubota M1250, M7030	KUM1250	95 / 43	
KU520	Kubota R520/R410/R420/R510	KU520	225 / 102	
LP5323	Land Pride 5323	LP5323		
IN05-00006	Massey 1036, 1038	M1038	95 / 43	
IN05-00005	Massey 1070, Fendt (T4)	M1070	133 / 60	

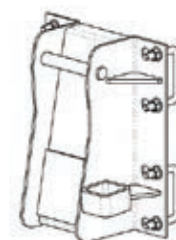

JD 240, 245, 260, 265



JD 244J

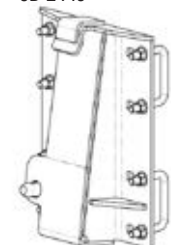

JD 400X

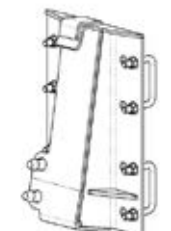
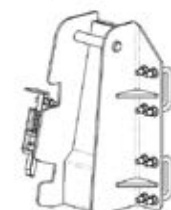
JD 520, 521, 540,  
541, 542JD 620, 640, 720,  
725, 740, 741

JRB 416

# QUICK ATTACH



Skid Steer plate



Skid Steer plate



Cat IT28



JCB 426HT



JD 544



JRB 41

PRODUCT NO	MODEL	OLD CODE	WEIGHT lb / kg
IN22-00003	Mustang 2040-50-60-70 Univ. QA	SSQA150	125 / 57
IN03-00011	New Holland B59B (T4)		125 / 57
IN03-00003	New Holland L454/55, L425	FNH455	183 / 83
IN03-00007	New Holland L555 (T4)		113 / 51
IN22-00009	SSL Case Special	SSQACase	60 / 27
IN22-00003	SSL Quick Attach.	SSQA150	125 / 57
IN39-00001	Thomas 1335, 135, 153, 173, 243, 245 QA	TH133	100 / 45
IN34-00001	Westendorf WL21/22/23/27	WE20Q	140 / 64
IN34-00001	Westendorf TA26/28/29, WW24	WE20Q	140 / 64
IN34-00001	Westendorf WL60/61/64	WE40Q	140 / 64
IN34-00001	Westendorf WL357/457/, TA45	WE40Q	140 / 64
IN34-00001	Westendorf TA46, TA48, XTA400	WE40Q	140 / 64

## FOR LOADERS

IN11-00001	Cat 950	CAT950	210 / 95
IN11-00010	Cat IT14/24/28 (T4)		250 / 113
CATIT28	Cat IT28, 936, 928 (T4)	CATIT28	205 / 93
IN11-00014	Cat IT28 (T5)		444 / 201
IN11-00015	Cat IT416/420/424	CATIT24	273 / 124
IN11-00022	Cat 936F/938F/938G		480 / 218
IN11-00020	Cat IT950/962/966/972 (T5)		482 / 219
IN11-00017	Cat 980B (T5)		789 / 358
IN09-00004	EDF (T4)	EDF	187 / 85
IN09-00009	EDF (T5)		377 / 171
IN13-00004	JCB 426 HT (T4)		345 / 157
IN13-00005	JCB 524 Telehandler (T4)		352 / 160
IN01-00046	JD 444E Direct (T5)		209 / 95
IN01-00044	JD 444J (T5)		307 / 139
IN21-00005	JRB 418 (T5)		409 / 186
IN26-00002	Vallee (T5)		543 / 246
IN16-00001	Volvo BL71 (T4)		320 / 145
IN16-00004	Volvo/L-120C (T4)	VOL	265 / 120
IN16-00010	Volvo L50/L70 (T4)		385 / 175



# GP SERIES



The GP-10 is the result of continuous improvements of our products. It is adaptable to all our material buckets from 5' to 9' (1.5 - 2.7 m). Made of double steel frame and chromolybdene teeth, the GP-10 is tough and durable. It is designed for use with tractors, skid steer loaders as well as telehandlers.



## GP-10 Model

DESCRIPTION	WEIGHT lb / kg	
2 Hydraulic cyl-c/w hoses (hose to tractor not supplied) C/W 4 chromolybdene steel teeth Bolts on to bucket	625 / 284	

OPTIONS		
Extra tooth		
Double Action Kit <i>For grabbing uneven objects. Bracketery &amp; Hydraulic fittings.</i>		

# SGP SERIES



Especially designed for heavy duty work the SGP-10 Series grapple is made to be used with the SHB material bucket. The SGP-10 is equipped with two powerful 3" (76 mm) hydraulic cylinders. It is built with the same components as the GP version but heavier. Adapted for industrial loaders, mini-excavators and other loading equipment such as telehandlers.

## SGP-10 Model

DESCRIPTION	WEIGHT lb / kg	
Grapple for forks SHB, 7' - 9' (2.1-2.7 m) 2 Hydraulic cylinders 3" (76 mm) dia. (hose to tractor not supplied) C/W 4 chromolybdene steel teeth Bolts on to bucket	700 / 317	

### OPTIONS

Extra tooth

Double Action Kit

*For grabbing uneven objects. Bracketery & Hydraulic fittings.*



# WD, PWD, SRR & SWD SERIES

Whichever size rake you choose, we insure the same product quality. Whether you purchase a three point mounted or pull type version, all rakes come standard with bolt on, reversible and replaceable teeth made of RT-400 steel which is 4 times stronger than market standards. All mechanical rakes are protected with a slip clutch system while the hydraulic version is pressure regulated.

All our frames are of the highest grade to support greater shocks and loads in rough field conditions, they are also driven by heavy duty double chains (single for WD-6) located in a sealed drive case for complete dust and rock protection.

## PWD-10:

In addition to the above standard features, the PWD-10 also includes a tilt system on the rear wheel to adjust to ground contour.

## SRR-15:

Bigger rakes require additional features such as the suspended drum that follow ground contour and absorb shocks from heavier rocks. Adjustable working angle and shield protection are other key standard features of the SRR-15. The rake is offered in 2 versions: mechanical or hydraulic drive. For ease of maintenance, the dual drive chain is adjustable via an eccentric tensioning system. Transport mode is set manually within minutes.

## SWD-15:

Our top of the line model, the SWD-15 is offered in 2 versions: mechanical or hydraulic drive, it has a longer drum and bigger drive bearings. Working angle is adjustable and transport mode is done hydraulically.

## Features:

1. Pull type or 3 point hitch.
2. Hydraulic transport system.
3. Heavy duty frame.
4. Floatation system (drum).
5. Protective shields.
6. Sealed chain case.
7. Dual chain.
8. Multiple disc slip clutch.
9. Heavy duty teeth replaceable and reversible.





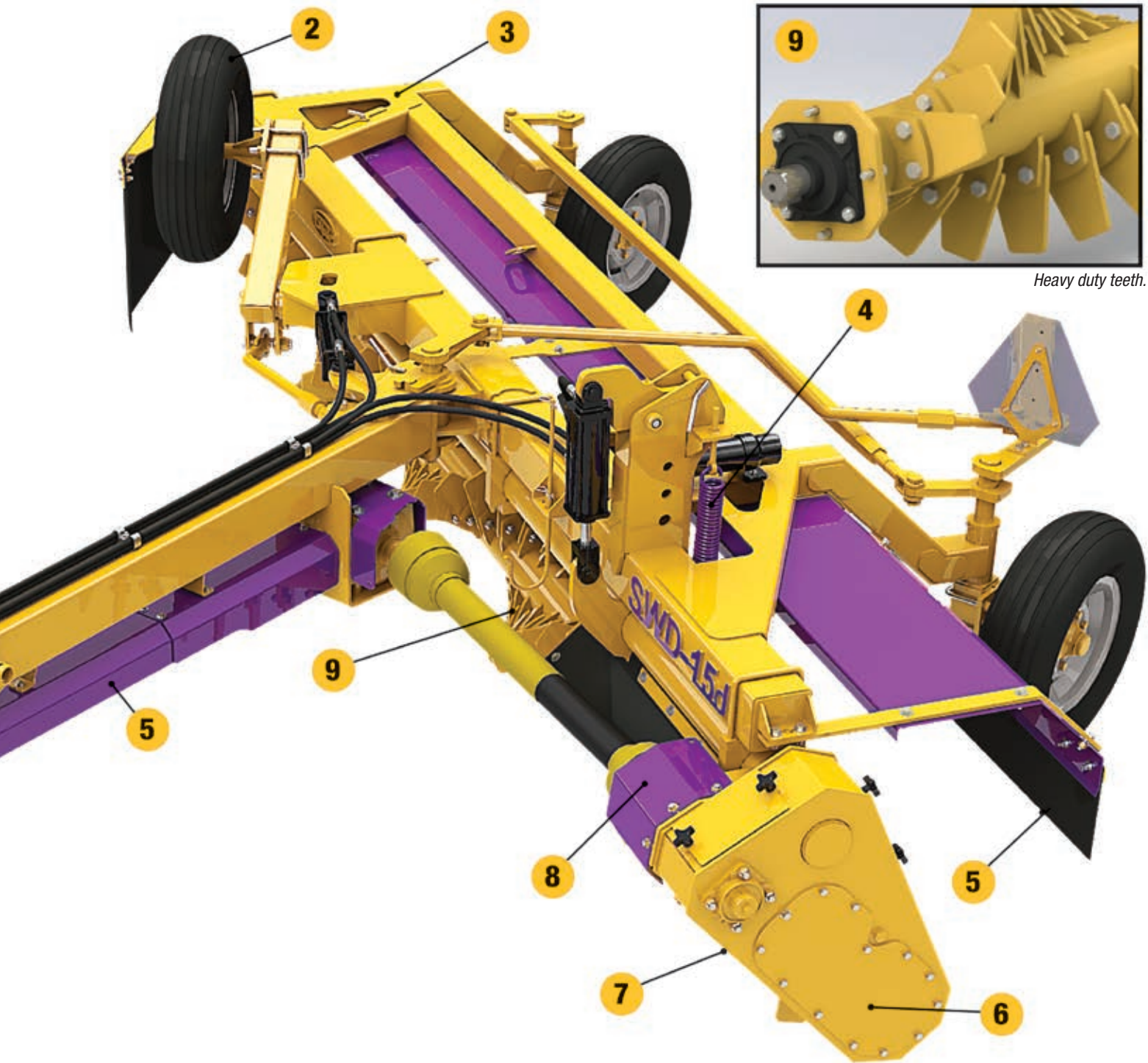

Heavy duty teeth.



Dual chain.



Multiple disc slip clutch.

# WD SERIES



The WD-6 and WD-10 rock rakes are made to move rocks into windrows making them easier to collect.

**Standard Equipment:**

**Tires:**

- WD-6 : 16.5" x 6.5" (419 x 165 mm).
- WD-10B : 18.5" x 8.5" (470 x 206 mm).

Able to pivot 360° allows for greater flexibility and maneuverability.

**Hookup:** 3 point hitch mounting system.

**Drop Box:** Sealed to eliminate dust as much as possible so to extend the life of internal components (chain, gears, bearings).

**Protection:** Slip clutch.

**Tooth Type:** RT-400 steel replaceable and reversible, 4x stronger than regular steel.

**Working Width:**

- WD-6: 5' 2" (1.6 m).
- WD-10: 8' 8" (2.7 m).



WD Series				
MODEL	WIDTH ft / m	WEIGHT lb / kg	RECOM. HP HP / KW	
WD-6	7.3 / 2.2	1150 / 522	40-60 / 30-48	
WD-10B	11.3 / 3.5	1850 / 839	65-125 / 48-93	

# PWD SERIES



The PWD-10 rock rake is designed to dig and move rocks into a windrow making them easy to collect.

**Standard Equipment:**

**Tires:** 11L/15.

**Hookup:** Pull type.

**Drop Box:** Sealed to eliminate dust as much as possible so to extend the life of internal components (chain, gears, bearings).

**Protection:** Slip clutch.

**Tooth Type:** RT-400 steel replaceable and reversible, 4x stronger than regular steel.

**Working Width:** 8' 8" (2.7 m).



PWD Series				
MODEL	WIDTH ft / m	WEIGHT lb / kg	RECOM. HP HP / KW	
PWD-10	11.3 / 3.5	2500 / 1134	65-125 / 48-93	

# SRR SERIES



The SRR-15 is designed to adapt to 65-125 HP (49-93 KW) tractors. It digs and moves rocks to form a windrow making them easy to pick up. Available in 2 versions: mechanical or hydraulic.

**Standard Equipment:**

**Tires:** 11L/15.

**Hookup:** Pull type.

**Drop Box:** Sealed to eliminate dust as much as possible so to extend the life of internal components (chain, gears, bearings).

**Protection:** Slip clutch or pressure relief for hydraulic drive.

**Tooth Type:** RT-400 steel replaceable and reversible, 4x stronger than regular steel.

**Working Width:** 13' (4 m).

**Other:**

- Setting transport is done manually.
- Width of transport 8' (2.43 m).
- Multiple guards.
- Flotation system.



## SRR Series

MODEL	WIDTH ft / m	WEIGHT lb / kg	RECOM. HP HP / KW
SRR-15	15.8 / 4.8	4275 / 1940	65-125 / 48-93
SRR-15 HYD	15.8 / 4.8	4775 / 2170	65-125 / 48-93

# SWD SERIES



The SWD -15 is designed to adapt to 65-125 HP (48-93 KW) tractors. It digs and moves rocks to form a windrow making them easy to pick up. It is offered in two different versions: mechanical or hydraulic drive.

**Standard Equipment:**

**Tires:** 11L/15.

**Hookup:** Pull type.

**Drop Box:** Sealed to eliminate dust as much as possible so to extend the life of internal components (chain, gears, bearings).

**Protection:** Slip clutch (or pressure relief for hydraulic drive).

**Tooth Type:** RT-400 steel replaceable and reversible, 4x stronger than regular steel.

**Working Width:** 13' 10" (4.2 m).

**Other:**

- Hydraulic transport setting.
- Width of transport 8' (2.43 m).
- Multiple guards.
- Flotation system.

SWD Series				
MODEL	WIDTH ft / m	WEIGHT lb / kg	RECOM. HP HP / KW	
SWD-15	16.7 / 5.1	4500 / 2040	65-125 / 48-93	
SWD-15 HYD	16.7 / 5.1	5000 / 2273	65-125 / 48-93	



# LNS, LN & SLN SERIES

Seed bed preparation is the most critical step to assure optimal yields. The role of the land leveler is to level the ground by eliminating mounds and hollows. Dirt is moved to fill in depressions where water tends to accumulate and stagnate.

At Fabrication S. Houle we have a complete range of land levelers that can help you accomplish this task. Our land levelers can be equipped with scarifying teeth designed to break hard ground surfaces, a GPS or a laser post for precision work, positioning headlights for road trips, agricultural or industrial tires mounted in tandem in order to reduce the machine's waddle, a hydraulic tilting system to work ground along the ditches. All of these are just a few of the long list of features that can be ordered when purchasing our land levelers.

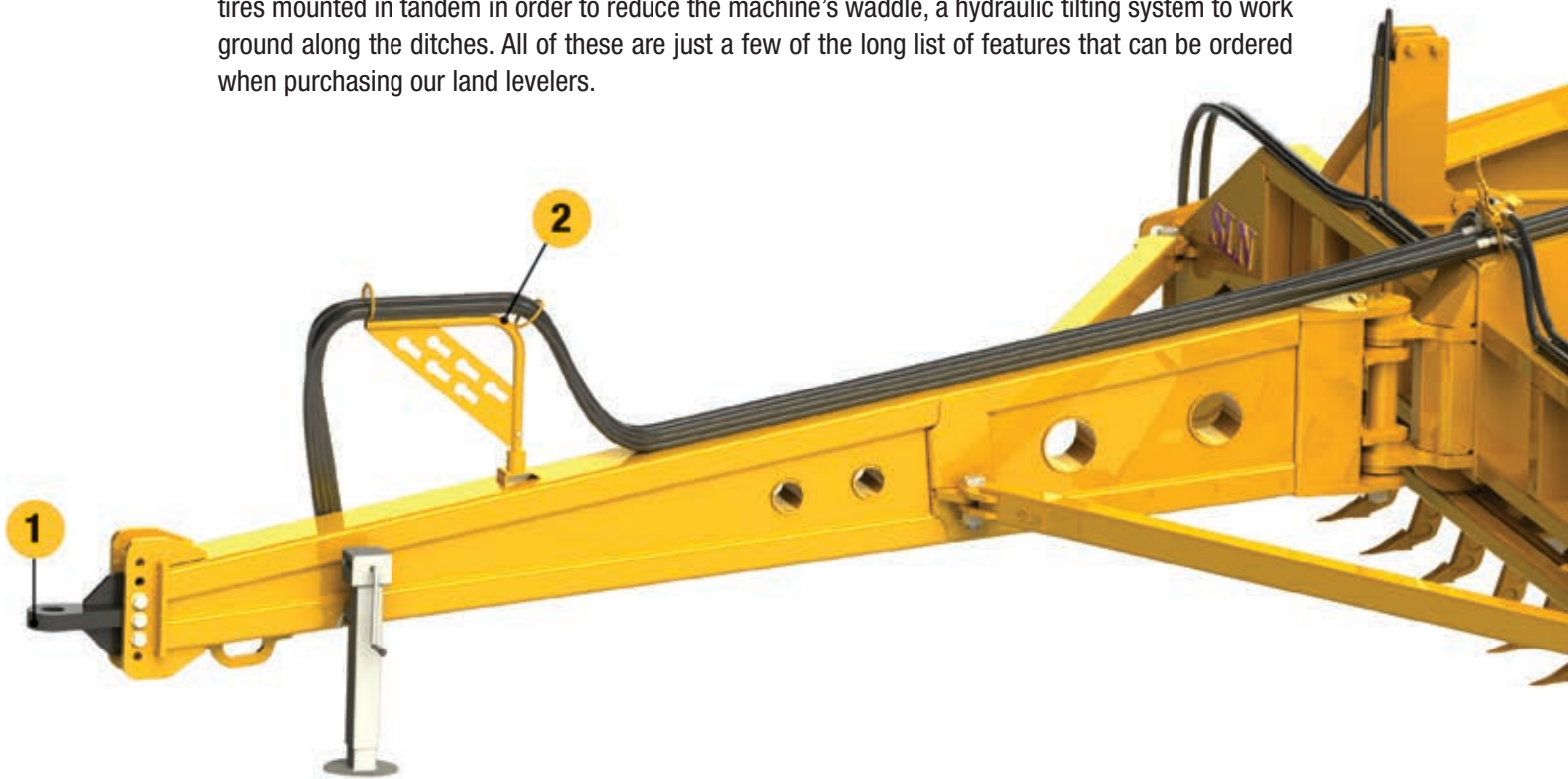

## Options:

1. Multiple ISO attach systems available depending on the type of tractor.
2. Hydraulic hose support.
3. Taillight kit for road trips. Comes standard with transport kit.
4. Laser or GPS post.
5. Carriage Lift Cylinder.
6. Cradle assembly: The frame is equipped with two hydraulic cylinders that can lift the blade about 20" (51 cm) above ground level.
7. A tilt system is available. This system can be installed either on the left hand, right or both sides at once. It allows the blade to tilt about 12" (30 cm).
8. The box blade is equipped with tires mounted in tandem using a floatation system to minimize the waddle. Used industrial tires are available at no extra cost (SLN models only).
9. High capacity hubs (5,000 - 12,000 - 16,000 lb / 2 250 - 5 500 - 7250 kg) depending on the model respectively LNS, LN or SLN, significantly reduce maintenance costs.
10. The land leveler has reversible hardened steel side cutters.
11. Stabilizing skid shoes are ideal for high speed finishing applications.
12. Hydraulically activated scarifying teeth system is available for breaking hard ground surface (up to 4" or 10 cm). Kit includes industrial grade teeth spread 18" (48 cm) apart that guarantee excellent ground penetration and breakage.

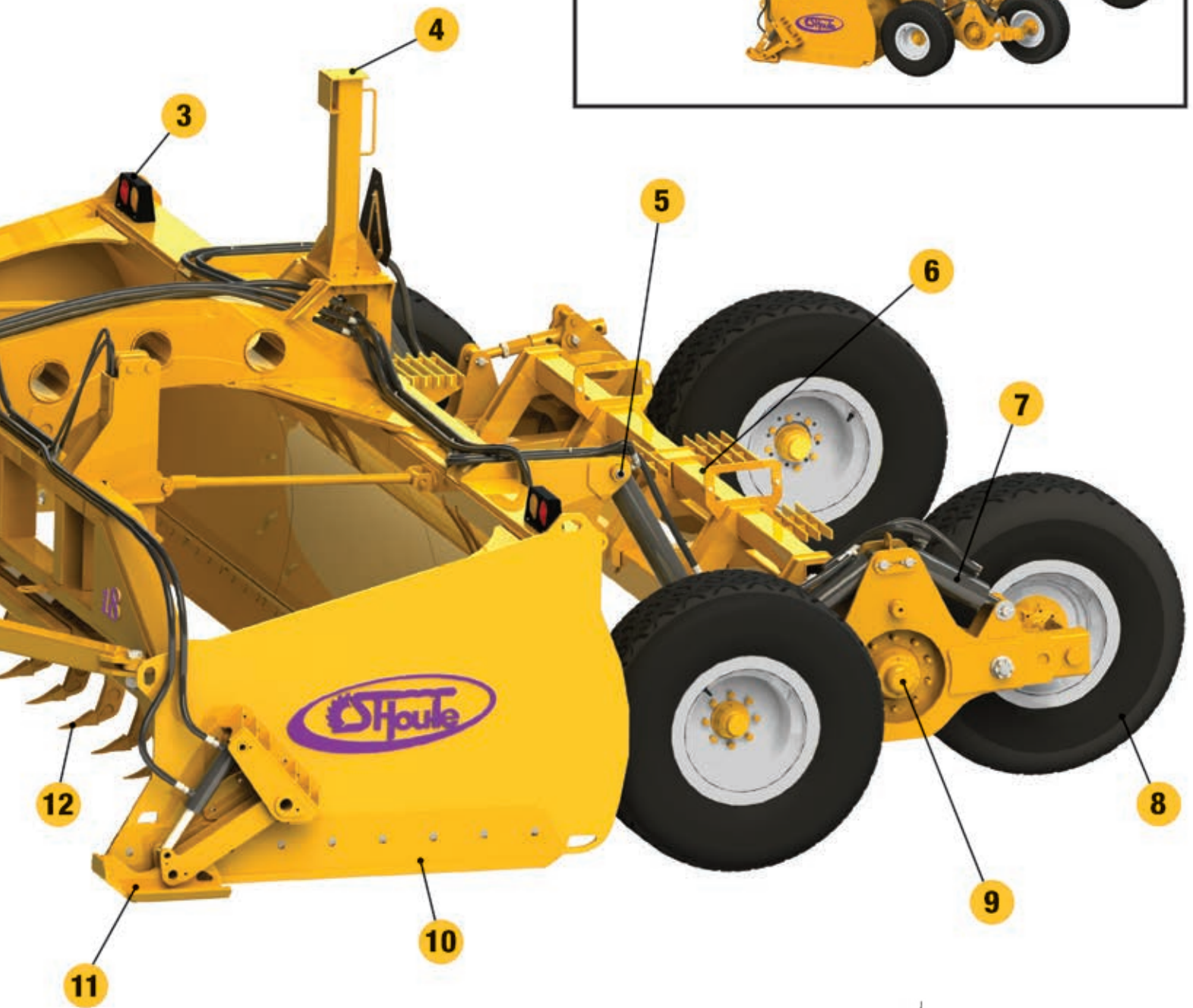

**Maximum clearance**

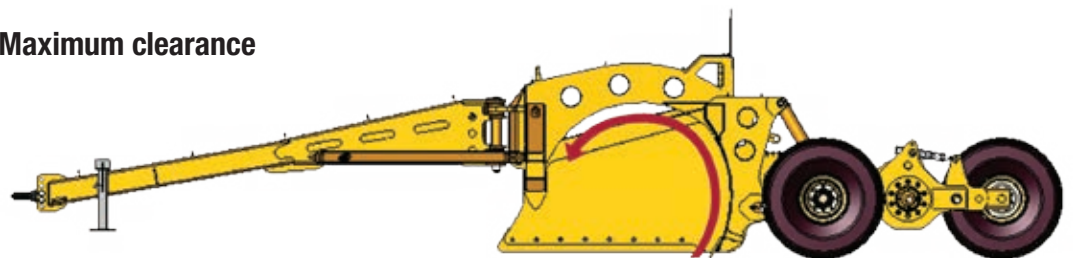

The unique design of our curved frame allows dirt to roll inside the basket thus increasing the capacity while preventing lifting of the unit.

# LNS & LN SERIES

## LNS Series 75 - 125 HP • 56 KW to 94 KW



MODEL	DESCRIPTION	WEIGHT <i>lb / kg</i>
LNS-12	Land Leveler 12' x 34" (3.7 m x 86 cm) Tires: 11L15, Wheels 15x8	3400 / 1542
LNS-14	Land Leveler 14' x 34" (4.3 m x 86 cm) Tires: 11L15, Wheels 15x8	3750 / 1700

### OPTIONS

Light kit	
Post for GPS receiver	
Post for LASER receiver	460.00
Articulated right tandem (tilt the blade up to 4 degrees)	
Articulated left tandem (tilt the blade up to 4 degrees)	
Articulated on both sides (right and left)	
Scarifying teeth kit 12' (3.7 m)	
Scarifying teeth kit 14' (4.3 m)	

## LN Series 100 - 250 HP • 75 KW to 190 KW



Articulated left tandem LN

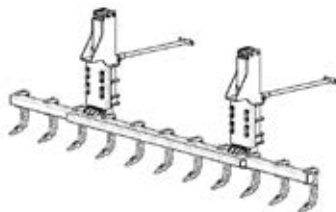

Scarifying teeth kit LN

MODEL	DESCRIPTION	WEIGHT <i>lb / kg</i>
LN-14	Land Leveler 14' x 42" (4.3 m x 107 cm) Tires: 12.5L15, Wheels 15x8	7415 / 3370
LN-16	Land Leveler 16' x 42" (4.8 m x 107 cm) Tires: 12.5L15, Wheels 15x8	8115 / 3688
LN-18	Land Leveler 18' x 42" (5.5 m x 107 cm) Tires: 31 x 15 .5-15 TL	8224 / 3738
LN-18T	Land Leveler 18' x 42" (5.5 m x 107 cm) with transport kit	9380 / 4264
	- Transport width 13.5' (4.1m)	

### OPTIONS

Single or double attachment	
Traction tires (31 x 15.5 - 15 NHS)	
Agricultural Light kit	
Post for GPS receiver	60 / 27
Post for LASER receiver	70 / 32
Articulated right tandem (tilt the blade up to 4 degrees)	+270 / 123
Articulated left tandem (tilt the blade up to 4 degrees)	+270 / 123
Articulated on both sides (right and left)	+530 / 241
Bidirectional articulated left tandem	+301 / 137
Bidirectional articulated right tandem	+301 / 137
Scarifying teeth kit	
14' (4.3 m)	1272 / 578
16' (4.8 m)	1316 / 598
18' (5.5 m)	1429 / 650



# SLN SERIES

## SLN Series 300 HP and + • 225 KW and +

MODEL	DESCRIPTION	WEIGHT lb / kg
SLN-16	Land Leveler 16' x 50" (4.9 m x 127 cm)	11,100 / 5045
SLN-18	Land Leveler 18' x 50" (5.5 m x 127 cm)	13,135 / 5970
SLN-18-T	Land Leveler 18' x 50" (5.5 m x 127 cm) with transport kit - Transport width 16,2' (4,92 m)	14,839 / 6745
SLN-20	Land Leveler 20' x 50" (6 m x 127 cm)	13,196 / 6000
SLN-20-T	Land Leveler 20' x 50" (6 m x 127 cm)with transport kit - Transport width 16,2' (4,92 m)	15,247 / 6930
SLN-24	Land Leveler 24' x 50" (7.3 m x 127 cm)	15,174 / 6900
SLN-24-T	Land Leveler 24' x 50" (7.3 m x 127 cm) with transport kit - Transport width 16,2' (4,92 m)	16,823 / 7647



Articulated left tandem SLN

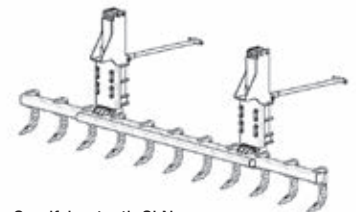

Scarifying teeth SLN



Stabilizer Skid Shoes SLN

### OPTIONS

Cat 4 attachment	
Light kit	
Safety access kit	217 / 98
Post for GPS receiver	60 / 27
Post for LASER receiver	70 / 32
Articulated right tandem (tilt the blade up to 4 degrees)	+402 / 183
Articulated left tandem (tilt the blade up to 4 degrees)	+402 / 183
Articulated on both sides (right and left)	+707 / 321
Bidirectional articulated left tandem	+430 / 195
Bidirectional articulated right tandem	+430 / 195
Scarifying teeth kit - SLN-18, SLN-18T	1587 / 721
Scarifying teeth kit SLN-20, SLN-20T	1623 / 738
Scarifying teeth kit SLN-24, SLN-24T	1447 / 658
Stabilizer Skid Shoes	600 / 273
<b>YOU CAN CHOOSE BETWEEN AGRICULTURAL OR USED INDUSTRIAL TIRES</b>	
Agricultural tires (16.5 X 16.1 TL)	
(Used) industrial tires (425/65R22.5)	

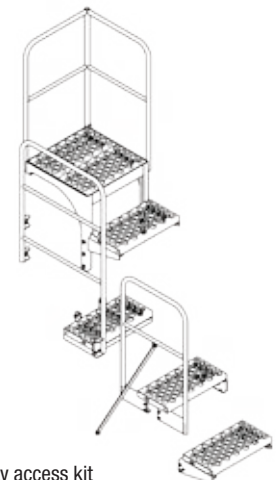

Safety access kit

# HLL SERIES



The HLL is designed to be used with utility tractors from 40 to 110 HP (30-82 KW). Best in its class in terms of strength and durability, the HLL box scraper can level almost any type of surfaces from gravel roads to fields. Tilt and height functions are controlled by 3 cylinders.

**Blade Height:** 30" (76 cm).

## HLL Series

MODEL	WEIGHT lb / kg	RECOM. HP HP / KW
HLL-08	1850 / 840	40-110 / 30-82
HLL-10	1875 / 850	60-110 / 45-82
HLL-12	1985 / 900	80-110 / 60-82

### OPTIONS

- Scarifying teeth kit 8' (2.4 m)
- Scarifying teeth kit 10' (3.0 m)
- Scarifying teeth kit 12' (3.7 m)



# LFA SERIES



The LFA is equipped with 4 cylinders which gives it high maneuverability. The 3 point hitch bracket of the LFA is designed to accept category 2 or 3 systems. With the rear wheel module (optional), the LFA can be transformed into a small land leveler. Side panels can also be added.

## LFA Series

MODEL	DESCRIPTION	WEIGHT lb / kg
LFA-08	3-pts hitch rear blade ditcher	1825 / 828
LFA-10	3-pts hitch rear blade ditcher	2020 / 916

### OPTIONS

- Side panel option
- Back wheel option



# TS SERIES

All our tree shears are designed to adapt to most tractors, loaders, telehandlers and skid steer loaders. They operate on standard or high flow hydraulics using one set of remote couplers only, a solenoid valve assembly controls the various applications. Because of their ability to rotate up to 110 degrees, our tree shears are ideal for adjusting to all cutting angles or simply to crimp a cut limb to move it away. The blades are made of the highest capacity steel (RT-400) for longer service life and reduced maintenance. Not only are they solid but the rigid blades will cut through wood without flexing with the grain.

## TS-08

Thanks to its narrow shape, the TS-08 is easy to handle and excels in reaching branches and trees in confined spaces.

## TS-16 (Treerex)

The particular geometry of the Treerex is shaped like a jaw with a lip that acts as a retaining hook, it keeps the tree or branch from moving away when cutting or transporting. The exclusive Teflon plate allows for a perfect cut eliminating the scuffing that occurs on most common models. Finally, the single blade action makes the whole operation easier to control as the tree or limb will fall perpendicular to the flat stopper.

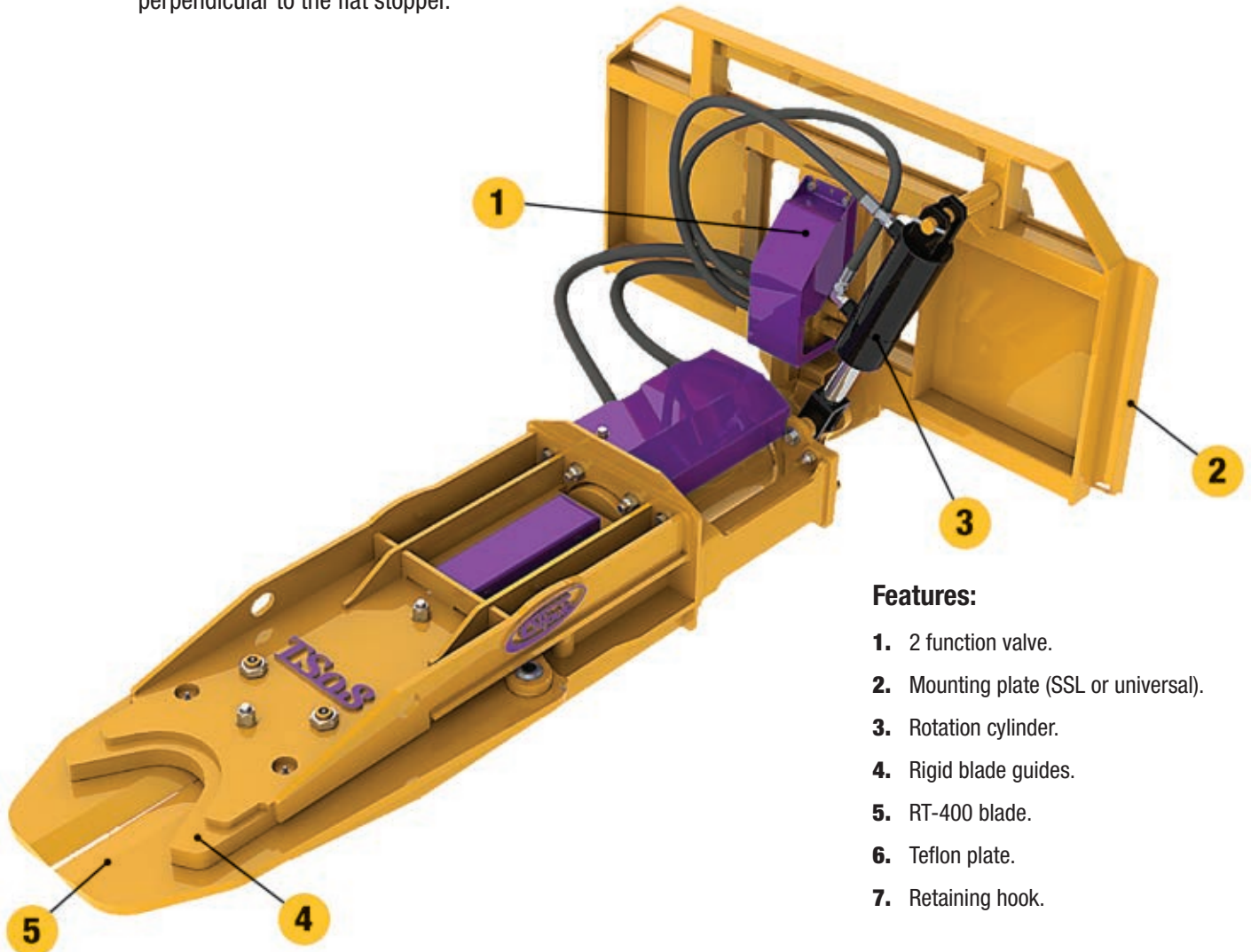

### Features:

1. 2 function valve.
2. Mounting plate (SSL or universal).
3. Rotation cylinder.
4. Rigid blade guides.
5. RT-400 blade.
6. Teflon plate.
7. Retaining hook.



*Cutting angle rotates.*



*Cuts through grain without bending.*

# TS-08 MODEL



The TS-08 hydraulic tree shear is designed to trim and cut trees growing in tight spaces and near fences. Its slim design lets you cut trees and branches up to 8" (20 cm) in diameter almost anywhere. It can also be used with small farm tractors, skid steer loaders and telehandlers to give you even more versatility.

**Length:** 67" (170 cm).

**Width:** 21" (53 cm).

**Tree Cutting Power:**

85,000 lb @ 3000 PSI / 38,000 kg @ 206 bars.

**Working angles:** 0-90°.

**Blade:** RT-400 Steel.

**Valve:** Solenoid 2 functions 1 command.

**Hydraulic Outlet:** 1.

**Minimum Oil Flow:**

15 GPM @ 2750 PSI / 70 l/m @ 190 bars.



## TS-08 Model

MODEL	DESCRIPTION	WEIGHT lb / kg	
TS-08	Tree shear 8" (20 cm) Univers. att.	1050 / 476	
TS-08-SS	Tree shear 8" (20 cm) Skid steer	1124 / 510	

### OPTIONS

Cat Plug

# TS-10+ MODEL



The TS-10+ model hydraulic tree shear is ideal for cutting branches or small trees up to 10" (25 cm) in diameter. Its grapple helps to gain access and handle trees in tight spots. Designed to adapt on mini-excavators.

**Length:** 36" (92 cm).

**Width:** 31" (80 cm).

**Tree Cutting Power:**  
85,000 lb @ 3000 PSI / 38,000 kg @ 206 bars.

**Working angles:** 0-90°.

**Blade:** RT-400 steel.

**Valve :** Solenoid 2 functions 1 command.

**Hydraulic Outlet:** 1.

**Minimum Oil Flow:**  
15-20 GPM @ 3000 PSI / 70-90 l/m @ 206 bars.

## TS-10+ Model

MODEL	DESCRIPTION	WEIGHT lb / kg
TS-10+	Tree shear 10" (25 cm)	900 / 408



# TS-16 MODEL (TREEREX)



The Treerex is the most powerful tree shear on the market; it is capable of cutting branches or trees up to 16" (41 cm) in diameter. Its single blade action allows for better control and quality of cut and its ability to rotate allows you to easily cut at angles or move fallen trees. Its low profile allows to cut trees at ground level. It is especially designed for skid steer loaders and telehandlers.

**Length:** 60" (150 cm).

**Width:** 58" (147 cm).

**Tree Cutting Power:**

85,000 lb @ 3000 PSI / 38,000 kg @ 206 bars.

**Working angles:** 0-110°.

**Blade:** RT-400 steel.

**Valve:** Solenoid 2 functions 1 command.

**Hydraulic Outlet:** 1.

**Minimum Oil Flow:**

20-25 GPM @ 2750 PSI / 90-114 l/m @ 190 bars.



## TS-16 Model (Treerex)

MODEL	DESCRIPTION	WEIGHT lb / kg
<b>TS16</b>	Tree shear 16" (41 cm) Univers. att.	1550 / 703
<b>TS16-SS</b>	Tree shear 16" (41 cm) Skid steer	1550 / 703

## OPTIONS

TS-16 Guard	155 / 70
TS-16-SS Guard	165 / 75
Cat Plug	
High flow solenoid (12 volts)	
High flow solenoid (24 volts)	
Standard solenoid (12 volts)	
Standard solenoid (24 volts)	





# NOTHING COMPARES

Fabrication S.Houle is an agricultural and commercial machinery manufacturer. We are the manufacturer of the original rock fork.

We manufacture some of the most robust products on the market, such as grapples, rock rakes, land levelers and snow removal equipment as well as many quick attaches for all types of tractors and compact loaders.

Fabrication S.Houle, **Built to Last!**

**1 YEAR**  
**WARRANTY**  
PARTS AND LABOR

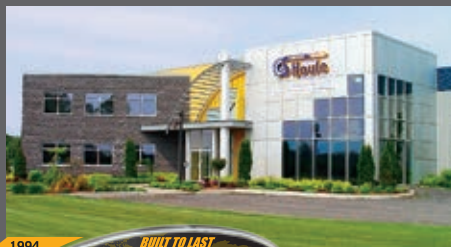

1994

BUILT TO LAST



2014

300 boul. Industriel, P.O. Box 750  
Saint-Germain-de-Grantham, QC J0C 1K0  
Tel.: 819 395-4380  
Fax: 819 395-5516  
info@shoule.com

**1 888 404-4380**  
**www.shoule.com**